

CIRCUIT BOARD HARDWARE

SECTION
VIII

KEY-SLOT P.C.B. POSTS

Molded in **Natural Nylon 6/6**

For use in combination with a key-slot hole so that the circuit board may be removed for repairs.

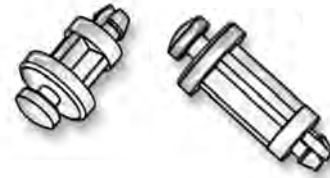

ITEM NUMBER	DESCRIPTION	A
27KYP00187	KYP 187	3/16 (4,8)
27KYP00250	KYP 250	1/4 (6,4)
27KYP00375	KYP 375	3/8 (9,5)
27KYP00500	KYP 500	1/2 (12,7)
27KYP00625	KYP 625	5/8 (15,9)
27KYP00750	KYP 750	3/4 (19,1)
27KYP00875	KYP 875	7/8 (22,2)
27KYP01000	KYP 1000	1 (25,4)

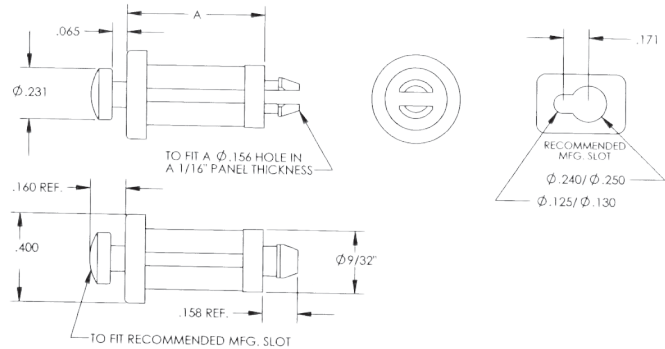

P.C. BOARD CARD GUIDES

Molded in **Natural Nylon 6/6**

Micro Plastics' Printed Circuit Board Support Guides are an economical and fast solution to mount P.C. Boards. Card insertion is simple and fast. The smooth positive channel guides the P.C. Board and firmly supports and protects the board. Guides are molded of tough, electrically insulating nylon 6/6 and are designed to snap into pre-punched holes in the chassis. Micro Plastics has available the eight most popular sizes. Other sizes will be tooled on request.

The Printed Circuit Board Card Guide is designed to fit a .125" front diameter hole and a .120" x .218" slot rear hole.

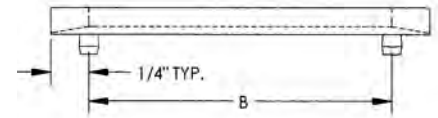
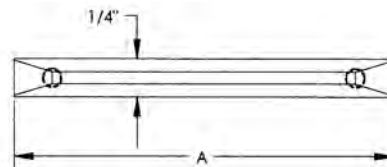
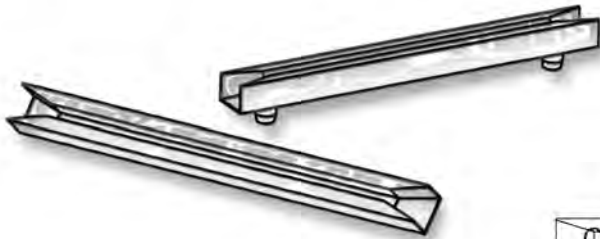

ITEM NUMBER	DESCRIPTION	A	B	LEG DESIGN
21CGS00250WS	2 1/2" GUIDE WITH SPLIT LEGS	2.5 (63,50)	2.0 (50,80)	Slotted Leg Design
21CGS00250	2 1/2" GUIDE	2.5 (63,50)	2.0 (50,80)	Solid Leg Design
21CGS00300WS	3" GUIDE WITH SPLIT LEGS	3.0 (76,20)	2.5 (63,50)	Slotted Leg Design
21CGS00300	3" GUIDE	3.0 (76,20)	2.5 (63,50)	Solid Leg Design
21CGS00350WS	3 1/2" GUIDE WITH SPLIT LEGS	3.5 (88,90)	3.0 (76,20)	Slotted Leg Design
21CGS00350	3 1/2" GUIDE	3.5 (88,90)	3.0 (76,20)	Solid Leg Design
21CGS00400WS	4" GUIDE WITH SPLIT LEGS	4.0 (101,60)	3.5 (88,90)	Slotted Leg Design
21CGS00400	4" GUIDE	4.0 (101,60)	3.5 (88,90)	Solid Leg Design
21CGS00450WS	4 1/2" GUIDE WITH SPLIT LEGS	4.5 (114,30)	4.0 (101,60)	Slotted Leg Design
21CGS00450	4 1/2" GUIDE	4.5 (114,30)	4.0 (101,60)	Solid Leg Design
21CGS00500WS	5" GUIDE WITH SPLIT LEGS	5.0 (127,00)	4.5 (114,30)	Slotted Leg Design
21CGS00500	5" GUIDE	5.0 (127,00)	4.5 (114,30)	Solid Leg Design
21CGS00550WS	5 1/2" GUIDE WITH SPLIT LEGS	5.5 (139,70)	5.0 (127,00)	Slotted Leg Design
21CGS00550	5 1/2" GUIDE	5.5 (139,70)	5.0 (127,00)	Solid Leg Design
21CGS00600WS	6" GUIDE WITH SPLIT LEGS	6.0 (139,70)	5.5 (139,70)	Slotted Leg Design
21CGS00600	6" GUIDE	6.0 (139,70)	5.5 (139,70)	Solid Leg Design

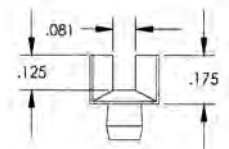
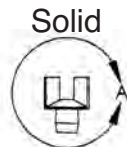

Slotted

