

THIS DOCUMENT IS THE PROPERTY OF
KEYSTONE ELECTRONICS CORP. AND
SHALL NOT BE REPRODUCED, DISTRIBUTED
OR USED AS A BASIS FOR MANUFACTURE
WITHOUT PRIOR WRITTEN PERMISSION
FROM KEYSTONE ELECTRONICS CORP.

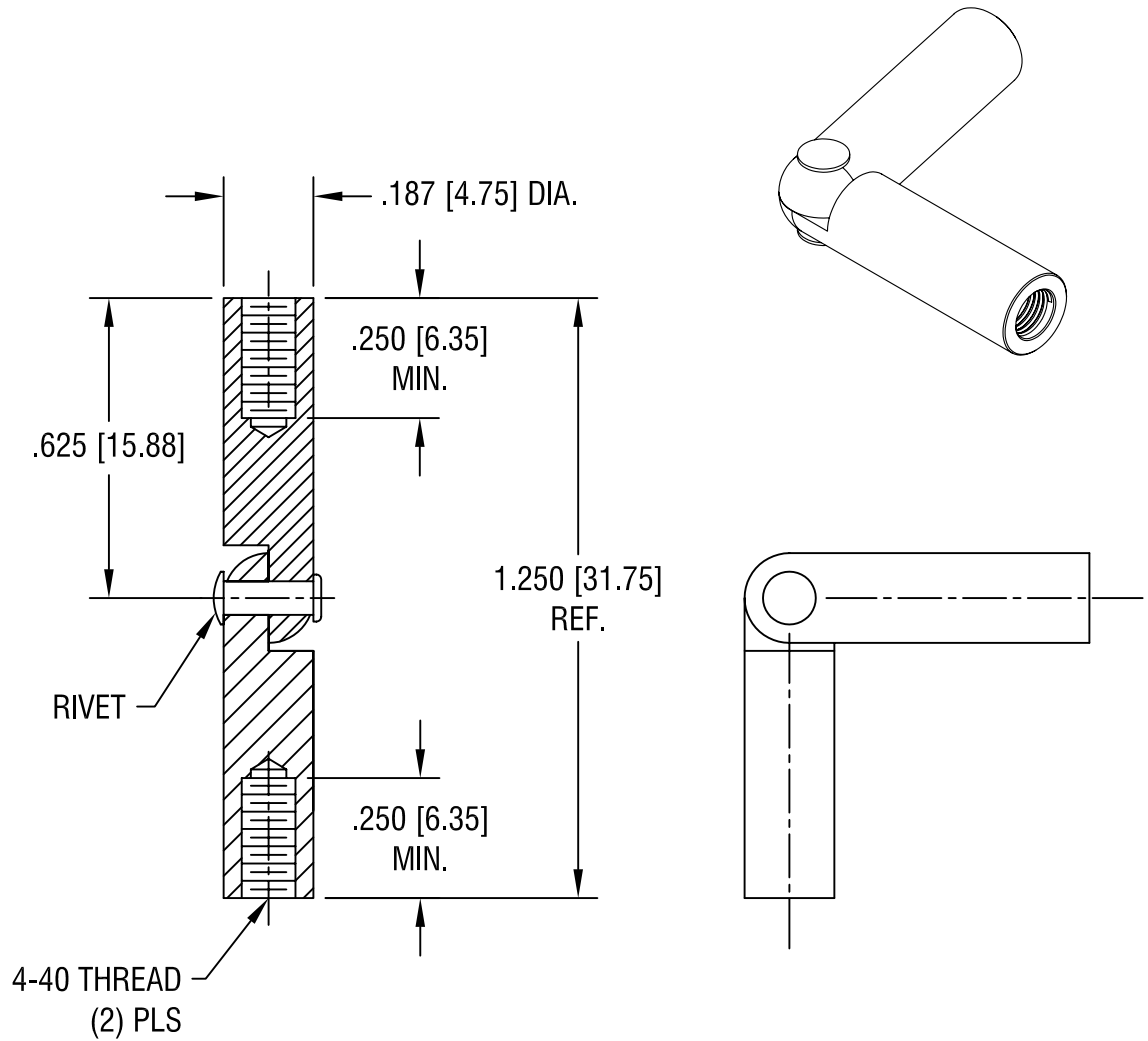

KEYSTONE ELECTRONICS CORP.

www.keyelco.com • ASTORIA, N.Y. 11105-2017 • Tel (718) 956-8900

PART NAME

HINGED STANDOFF, FEMALE/FEMALE

MATERIAL

BRASS

FINISH

ZINC PLATE WITH
YELLOW CHROMATE

DRN BY

BOONE

DATE

9.18.95

APP'D

LN

SCALE

2.5X

9.08.08

CHANGE AS PER ECN 08-148

A

TOLERANCES

INCH [MM]

CODE

DWG NO.

DECIMAL

± .005 [± 0.15]

C

ANGULAR

± 1°

UNLESS OTHERWISE SPECIFIED

330

DATE

DESCRIPTION

REV.